

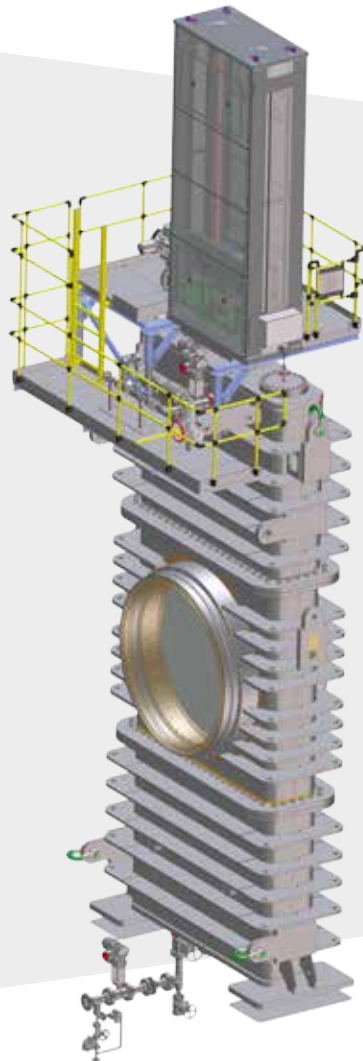

# Fluidised Catalytic Cracking Unit Fractionator Isolation Valves



 Engineering  
**GREAT** Solutions

**Double Disc Through Conduit –  
Double Block and Purge**

# Fluidised Catalytic Cracking (FCC) Fractionator Isolation Valves

Our Double Disc Through Conduit (DDTC) gate valves boast the latest technology available. It offers true double block and purge performance within one valve body by means of two independent, separate shut-off discs. The design minimizes seat wear due to the internal split-wedge-ball device, which gives clearance to move and releases the seat-force prior to gate movement. The DDTC valve has been specially developed to handle abrasive media under high temperature, providing reliable, positive tight shut-off.

## Key features

- > Double-Block and Purge shut-off (offers the same functionality like a blind flange)
- > Internal components kept clean of medium
- > Seats protected, in both the open and closed positions, from erosion and coking medium
- > Mounting orientation flexibility – horizontal, vertical, etc
- > Stiff valve body protects against line loads
- > Sizes from 6” to 100”
- > Line Connections can be welded-in or flanged w/ blanking system
- > Material specifications dictated by design and operating conditions

## Benefits

- > Fully automatic isolation of Fractionator
- > Operation of the automatic isolation valve within minutes (manual operation up to 12h)
- > Ensures safety of operates - no exposure to elevated temperature
- > Cost efficiencies minutes versus 12 hours of manual process
- > Requires minimal down-time
- > Safeguards plant - no explosive environment from replaced gases with manual process

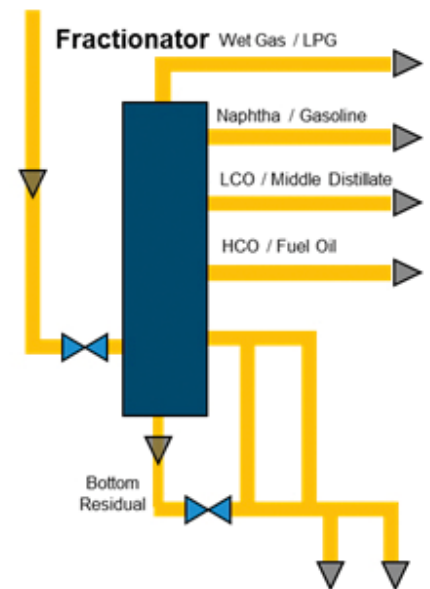

Valve in open position

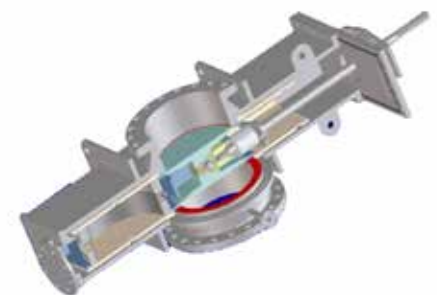

Valve in closed position

## Technical summary

Shutting down the FCCU cracking side requires isolating the Fractionator from the Main Column. This is done by the removal of a spacer and installation of a blank plate. This blinding location is at the Fractionator Overhead Vapor inlet to the Main Column. When the Overhead Vapor line is parted to remove the spacer, personnel are exposed to a hydrocarbon rich stream at 300°F. Since conditions for a flash fire are present, personnel perform this work in high temperature Proximity Suits, and under fresh air. Personnel and equipment are exposed to these hydrocarbon rich, high temperature conditions up to 12 hours as the blind is being installed. When this connection is separated on unit startup, personnel are again exposed to elevated process temperature as high as 600°F. In all, approximately 36 total hours during startup and shutdown are expended. The isolation of the Reactor from the Main Column is a part of the critical path for unit startup and shutdown.

## Product specification

- > Fluid: Reactor Effluent
- > Temperature: 530°C
- > Pressure: 1,6 barg
- > Line size: 6" - 100"

Other temperature/line/pressure conditions on request

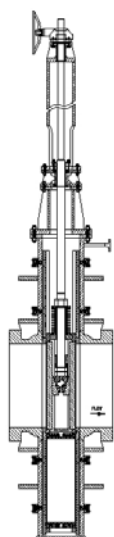

Flanged

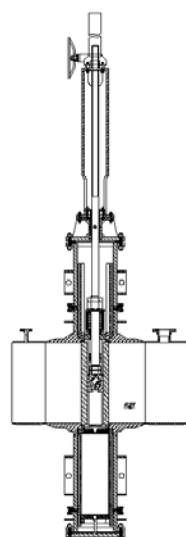

Weld -Ends

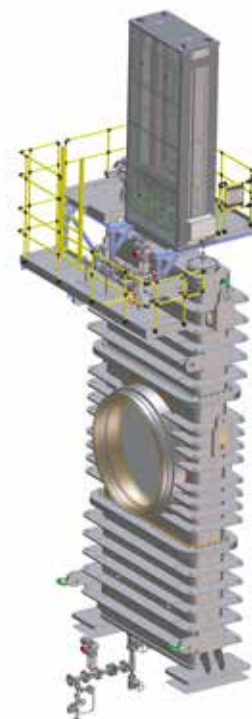

Bespoke designs and sizes including operator control panels and platform

**IMI Z&J Germany**

Bahnstrasse 52  
52355 Düren  
Germany

Tel: +49 (0)2421 691 0

E-Mail: [imizandj.germany@imi-critical.com](mailto:imizandj.germany@imi-critical.com)

**IMI Z&J Houston**

4525 Kennedy Commerce Drive  
Houston  
TX 77038  
USA

Tel: +1 281 446 8000

E-Mail: [imizandj.usa@imi-critical.com](mailto:imizandj.usa@imi-critical.com)

**IMI Z&J Shanghai**

No. 2 Workshop  
No. 819 Yinchuan Road  
Minhang Dist.  
Shanghai 201109  
China

Tel: +86 21 6490 7780

Email: [imizandj.china@imi-critical.com](mailto:imizandj.china@imi-critical.com)

**IMI Z&J South Africa**

Zimmerman & Jansen S.A.(Pty.) Ltd.  
11 Michelin Street  
P.O. Box 1335  
Vanderbijlpark  
1900  
South Africa

Tel: +27 16 986 0159

Email: [imizandj.sa@imi-critical.com](mailto:imizandj.sa@imi-critical.com)

**IMI Critical Engineering**

Lakeside, Solihull Parkway  
Birmingham Business Park  
Birmingham B37 7XZ  
United Kingdom

Tel: +44 (0)121 717 3700

Fax: +44 (0)121 717 3701

[www.imi-critical.com](http://www.imi-critical.com)